

Download

DXF 2D
- 492.dxf

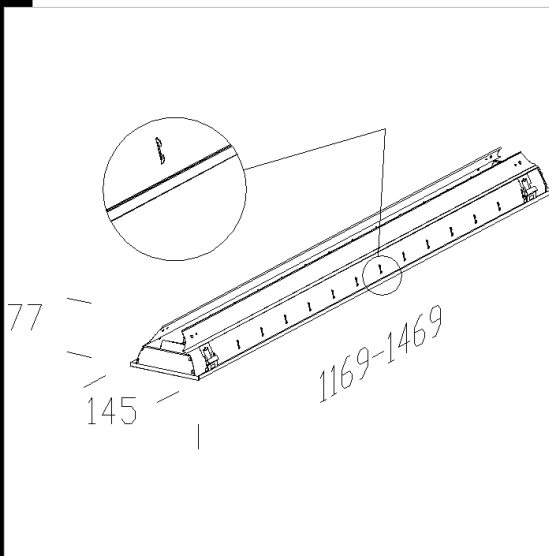

Codice	Kg	Lumen-K-CRI	WTot
993889-00	1.55	54---	0 W
993890-00	1.46	49---	0 W

Prodotti



- 1945 Speed T5 - lampade in



- 1930 Speed T5 - senza

Il flusso luminoso riportato indica il flusso uscente dall'apparecchio con una tolleranza di $\pm 10\%$ rispetto al valore indicato. I W tot sono la potenza totale assorbita dal sistema e non supera il 10% del valore indicato.