

467 Braccio

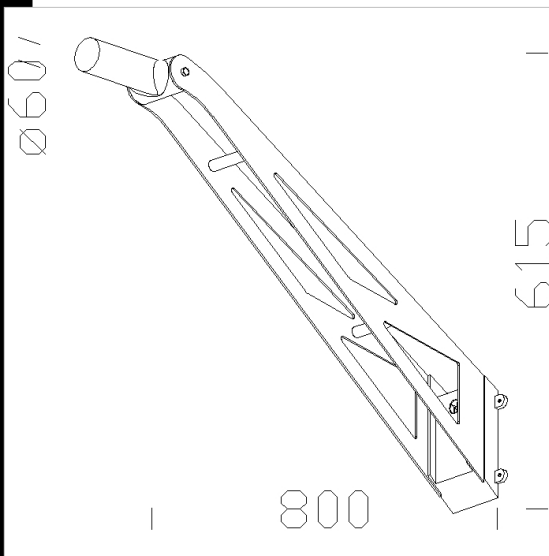









Download

- DXF 2D
- 466.dxf
- 3DS
- disano_467.3ds
- 3DM
- disano_467.3dm



Code	Kg	WTot	Colour
991413-00	7,99	0 W	ARGENTO SABBBIATO

Prodotti

 - 1755 Monza - con vetro piatto	 - 1756 Monza HP - high	 - 3185 Sforza Ø500	 - 3187 Sforza Ø600
 - 3190 Sforza Ø500 - piste ciclabili	 - 3182 Sforza Ø500 - attraversamenti pedonali SX	 - 3184 Sforza Ø500 - attraversamenti pedonali DX	 - 3223 Sforza LED a frusta - asimmetrico
 - 3189 Sforza Ø500 - arredo urbano	 - 1756 Monza FX		

The reported luminous flux is the flux emitted by the light source with a tolerance of ± 10% compared to the indicated value. The W tot column indicates the total wattage absorbed by the system without exceeding 10% of the indicated