

IK08 CNR-F CELL-F

IP66



## 1221 Bastia

Corpo: In alluminio pressofuso.  
Cappello: Pressofuso di alluminio.  
Diffusore: In policarbonato infrangibile ed autoestinguente V2, stabilizzato ai raggi UV. All'interno del diffusore è situato uno schermo lamellare per direzionare verso il basso il fascio luminoso.

### Download

- DXF 2D  
- 1221.dxf
- 3DS  
- disano\_1221\_bastia.3ds
- 3DM  
- disano\_1221\_bastia.3dm
- Montaggi  
- bastia.pdf  
- bastia\_compo.dxf

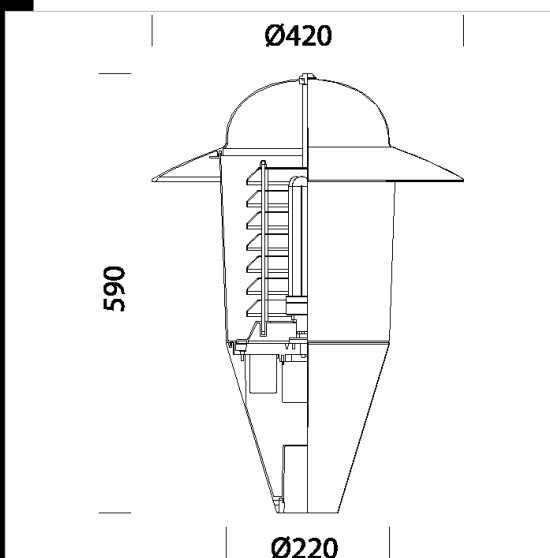



Code	Gear	Kg	Watt	Base	Lamps	Colour
424236-00	CNRL-F	5,95	SAP-E 100	E40	--	GRAFITE
424229-00	CNRL-F	5,67	SAP-E 70	E27	--	ARGENTO SABBIATO
424235-00	CNRL-F	5,67	SAP-E 70	E27	--	GRAFITE
424231-00	CNRL-F	5,92	SAP-E 100	E40	--	ARGENTO SABBIATO
424238-00	CNRL-F	3,84	JM-E 100	E27	--	GRAFITE
424237-00	CNRL-F	5,67	JM-E 70	E27	--	GRAFITE
424233-00	CNRL-F	5,69	JM-E 100	E27	--	ARGENTO SABBIATO
424232-00	CNRL-F	3,81	JM-E 70	E27	--	ARGENTO SABBIATO

### Accessori

 - 300 Oliva

 - 301 braccio Oliva

 - 1464 Corona

 - 1465 Flangia ø120

 - 129 Braccio curvo

 - 303 attacco ø 60

 - 1362 Braccio in su

 - 1365 Flangia ø100

 - 1364 Corona ø100

 - 1462 Braccio in su

### Pali

 - 1508 Palo rigato ø120 con base

 - 1509 Palo rigato ø120

 - 1408 Palo rigato ø100 con base

 - 1481 palo conico in acciaio da interrare

Pali



- 1480 palo conico in acciaio con base



- 5 Palo in vetroresina



- 1409 Palo rigato ø100