

iSpot Hotel 1 - DIMM

Corpo: In alluminio pressofuso.
 Riflettore: In policarbonato metallizzato ad alto rendimento.
 Normativa: Prodotti in conformità alle norme EN 60598-1-CEI 34.21, hanno grado di protezione secondo le norme EN 60529.
 LED: Mantenimento del flusso luminoso al 80%: 50.000h (L80B20).
 Fattore di potenza: >0,9.
 Classificazione rischio fotobiologico: gruppo esente.

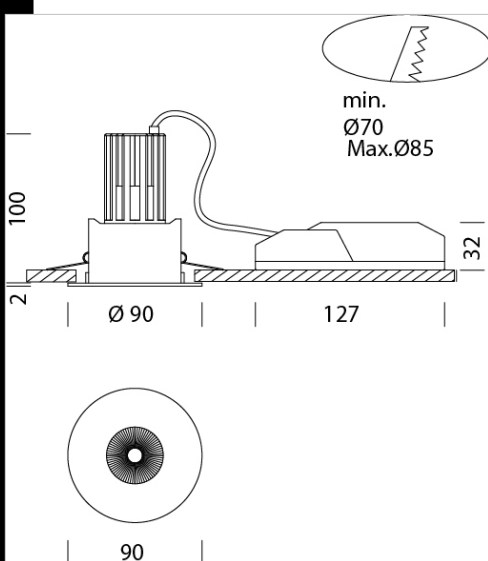

Code	Gear	Kg	Lumen Output-K-CRI	WTot	Colour
22067710-00	CLD CELL-DI	0,42	LED COB-413lm-3000K-15°-CRI 92	10 W	BIANCO
22067711-00	CLD CELL-DI	0,43	LED COB-478lm-4000K-15°-CRI 92	10 W	BIANCO
22067710-1241	CLD CELL-D-D	0,45	LED COB-413lm-3000K-15°-CRI 92	10 W	BIANCO
22067711-1241	CLD CELL-D-D	0,45	LED COB-478lm-4000K-15°-CRI 92	10 W	BIANCO



Download

DXF 2D
 - ispothotel1.dxf

The reported luminous flux is the flux emitted by the light source with a tolerance of $\pm 10\%$ compared to the indicated value. The W tot column indicates the total wattage absorbed by the system without exceeding 10% of the indicated