

Sospensione semplice

Incluye cable de acero con un dispositivo para el ajuste milimétrico. Carga máx.: 20 kg.

Download

DXF 2D
- 3171.dxf

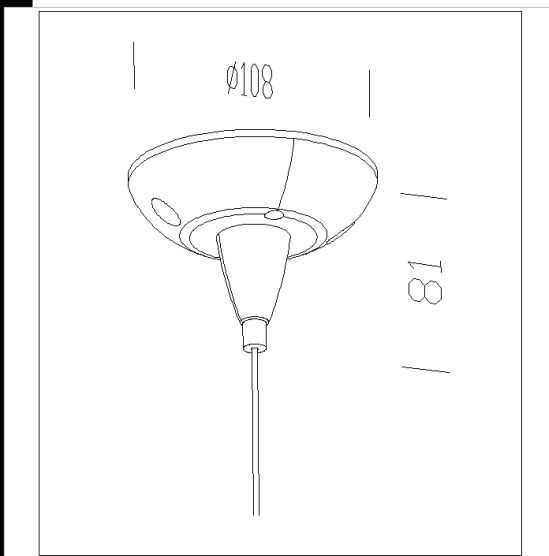

Code	Kg	WTot	Colour
22003171-00	0,20	0 W	ARGENTO
22003112-00	0,20	0 W	BIANCO



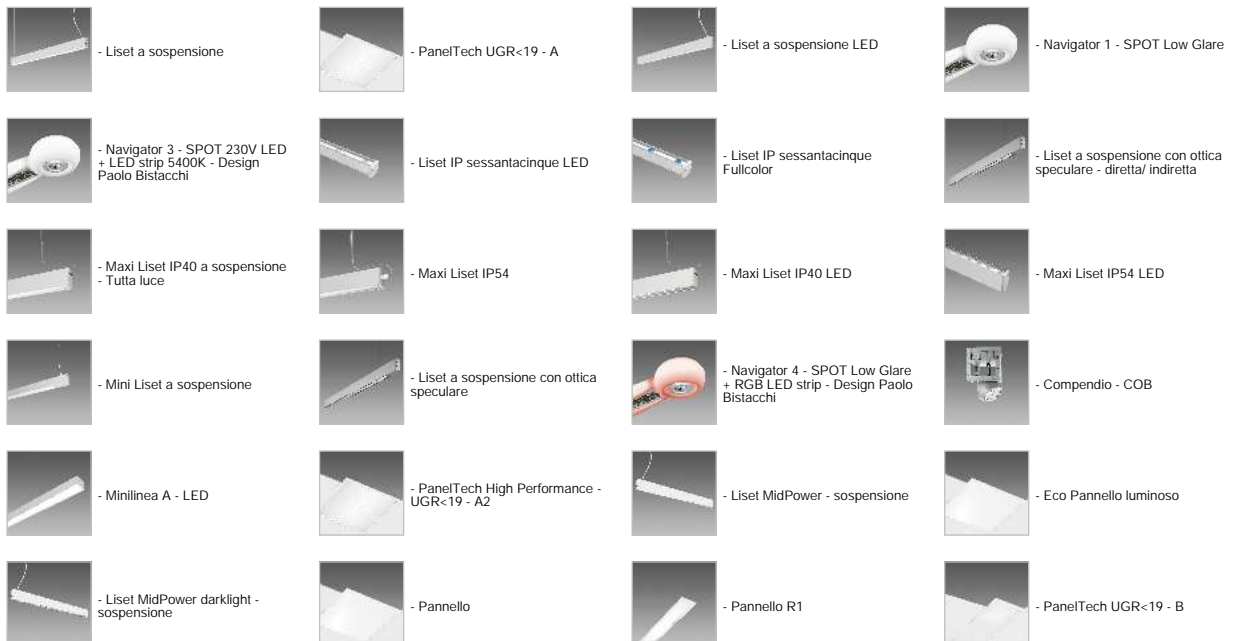





















Prodotti



The reported luminous flux is the flux emitted by the light source with a tolerance of $\pm 10\%$ compared to the indicated value. The W tot column indicates the total wattage absorbed by the system without exceeding 10% of the indicated

Sospensione semplice

Prodotti

	- PanelTech UGR<19 - R2		- PanelTech UGR<19 - R3		- Liset MidPower darklight - sospensione - Dir/indir		- Eco Pannello luminoso R2
	- Omnitrack PLUS - DIMM - 6 conduttori		- Omnitrack H - Dimm - 6 conduttori		- Sintesi System - a sospensione luce diretta/indiretta - diffondente		- Sintesi System - a sospensione con schermo UGR<19
	- Sintesi System - a sospensione luce diretta/indiretta - con schermo UGR<19		- Sintesi System - a sospensione ottica Dark - UGR<19		- Sintesi System - a sospensione luce diretta/indiretta - ottica Dark - UGR<19		- Sintesi System - a sospensione con schermo satinato - UGR<22
	- Sintesi System - a sospensione luce diretta/indiretta - con schermo satinato - UGR<22		- Sintesi System - plafone asimmetrica 25° - UGR<22		- Sintesi System - a sospensione luce diretta/indiretta - diffondente 60° - UGR<22		- Eco Pannello luminoso - CAM
	- Eco Pannello luminoso R2 - CAM		- Eco Pannello luminoso R4		- PanelTech High Performance - UGR<19 - A2 - CAM		- PanelTech High Performance - UGR<19 - R2 - CAM
	- Minilinea A - Dark - UGR<19		- Sintesi System - a sospensione diffondente		- Maxi Liset IP40 - Tutta luce		- PanelTech High Performance - UGR<19 - R2
	- PanelTech High Performance						

The reported luminous flux is the flux emitted by the light source with a tolerance of $\pm 10\%$ compared to the indicated value. The W tot column indicates the total wattage absorbed by the system without exceeding 10% of the indicated