

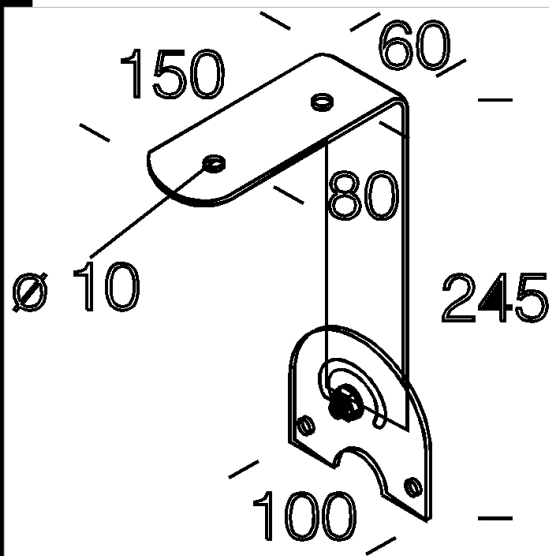







996 Staffa orientabile

In acciaio inox.
Permette la sospensione e la rotazione.



Codice	Kg	WTot	Colore
166670-00	1.05	0 W	INOX

Prodotti

 - 995 Gallery - bilampada FS	 - 1996 Gallery - bilampada FL	 - 998 Eterna - acciaio inox + vetro	 - 1997 Gallery - asimmetrico
 - 1992 Gallery - monolampada FS	 - 1993 Gallery - monolampada FL	 - 990 Steel T8 - Acciaio + vetro	 - 992 Eterna T8 - acciaio inox + vetro
 - 989 Eterna T8 - acciaio inox + policarbonato	 - 1994 Gallery - monolampada tipo stradale	 - 992 Eterna T5 - acciaio inox+vetro	 - 999 Forma T8 - acciaio inox+vetro
 - 994 Forma T8 - acciaio+vetro	 - 991 Steel T8 - Acciaio + policarbonato	 - 993 Forma ATEX - con vetro trasparente	 - 999 Forma T5 - acciaio inox+vetro
 - 994 Forma T5 - acciaio+vetro	 - 991 Steel T5 - Acciaio + policarbonato	 - 990 Steel T5 - Acciaio + vetro	 - 989 Eterna T5 - acciaio inox + vetro
 - 995 Forma LED - con vetro acidato	 - 993 Forma LED - vetro trasparente	 - 983 Forma LED - senza ganci per industria alimentare	 - 997 Forma LED - con diffusore in policarbonato
 - 988 Forma LED HT - High temperature			

Il flusso luminoso riportato indica il flusso uscente dall'apparecchio con una tolleranza di $\pm 10\%$ rispetto al valore indicato. I W tot sono la potenza totale assorbita dal sistema e non supera il 10% del valore indicato.