

1464 couronne

En aluminium moulé sous pression, peinture par cataphorèse époxy, de couleur noire avec finition bossée. Pour max 6 bras acc 1462 ou 1463 et poteaux 1408/1409. Munie de bornier. Double isolation.

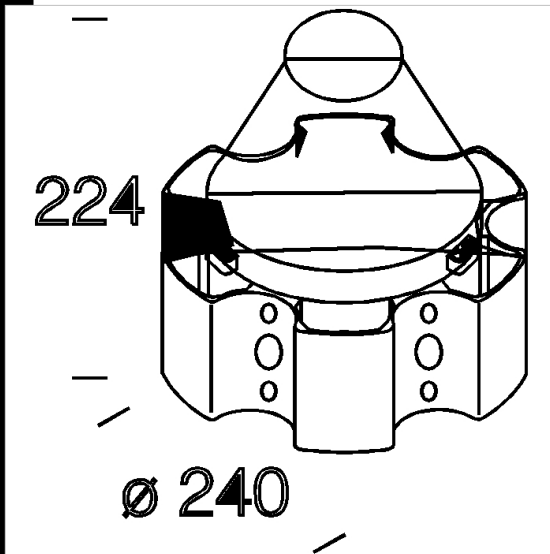

3DM
- disano_1464.3dm

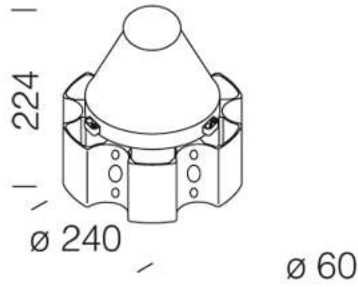

Code	Kg	WTot	Couleur
426984-00	1.60	0 W	NOIR
426990-00	1.83	0 W	GREY9007
427000-00	1.60	0 W	GRAPHITE

Pôles



- 1508 poteau strié Ø120 avec



- 1509 poteau strié Ø120

Produits



- 1765 Lanterna 1



- 1760 Lanterna 1 - avec lamellaire



- 1751 Metropolis intensif



- 1597 Vista - avec lamellaire



- 3131 Tex faisceau medium



- 1599 Vista d/i



- 3124 Ghost - lumière directe/indirecte



- 1762 Lanterna 1



- 1511 Torcia contre la pollution



- 1511 Torcia



- 1599 Vista contre la pollution



- 3172 Montecarlo



- 3174 Montecarlo verre



- 3136 Campana



- 3137 Campana



- 1770 Lanterna 2 - avec lamellaire



- 1502 Polar



- 3132 Tex faisceau large









































- 1763 Lanterna 1 - à lumière indirecte



- 1595 Vista - avec écran opale

Le flux lumineux mentionné est le flux lumineux sortant du luminaire, avec une tolérance de $\pm 10\%$ par rapport à la valeur indiquée. Les W totaux expriment la puissance totale consommée par le système avec une tolérance maximale de 10 %

Produits

	- 1752 Metropolis extensif		- 1320 Grande base		- 1214 Clima		- 3114 Ghost - lumière directe/indirecte
	- 1313 Base aluminium - câblage CNRL		- 1598 Vista - à lumière indirecte		- 1313 Base aluminium - câblage S/CNR		- 1771 Lanterna 2 - avec diffuseur
	- 1504 Clima		- 3188 Sforza Ø600 milieu de route		- 3183 Sforza Ø500		- 1513 Torcia LED COB
	- 1766 Lanterna LED		- 1753 Metropolis pistes cyclables		- 3186 Sforza Ø500 milieu de route		- 1514 Clima pour zone 1
	- 3171 Montecarlo - asymétrique		- 1598 Vista - pour Zone 1		- 3175 Montecarlo LED - extensif - elliptical lenses		- 1517 Clima LED
	- 3224 Sforza LED extensif		- 3142 Campana LED		- 1518 Clima LED contre la pollution lumineuse		- 1202 Polar
	- 3226 Sforza LED milieu de		- 1512 Bastia - LED		- 3227 Sforza LED		- 1221 Bastia
	- 1750 Metropolis		- 3141 Campana LED		- 3301 Visconti 2 - avec verre		- 3307 Visconti 8 LED -
	- 3310 Visconti 11 LED		- 3752 Metropolis - LED		- 3751 Metropolis - LED -		- 3146 Campana LED
	- 1204 Clima		- 1764 Lanterna 1 - à lumière				

Le flux lumineux mentionné est le flux lumineux sortant du luminaire, avec une tolérance de $\pm 10\%$ par rapport à la valeur indiquée. Les W totaux expriment la puissance totale consommée par le système avec une tolérance maximale de 10%