

## iSpot Hotel 3 - DIMM

Corps: en aluminium moulé sous pression  
 Réflecteur : polycarbonate métallisé haute performance.  
 Normes: produit conforme aux normes EN60598 - CEI 34-21 et ayant un indice de protection IP44IK07 selon les normes EN60529.  
 Groupe de risque photobiologique : Groupe 0 (exempt de risque).  
 Facteur de puissance:  $\geq 0,9$   
 Maintien du flux lumineux à 80%: 50.000h (L80B20).

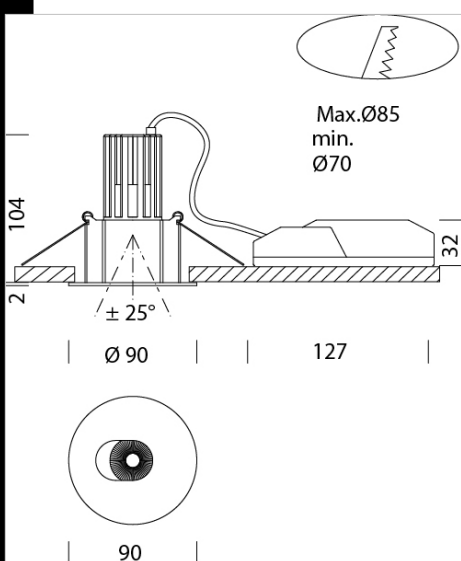

Code	Gear	Kg	Lumen Output-K-CRI	WTot	Colour
22067910-00	CLD CELL-DI	0,42	LED COB-380lm-3000K-15°-CRI 92	10 W	BIANCO
22067911-00	CLD CELL-DI	0,43	LED COB-441lm-4000K-15°-CRI 92	10 W	BIANCO
22067910-1241	CLD CELL-D-D	0,37	LED COB-380lm-3000K-15°-CRI 92	12 W	BIANCO
22067911-1241	CLD CELL-D-D	0,45	LED COB-441lm-4000K-15°-CRI 92	10 W	BIANCO



### Download

DXF 2D  
 - ispothotel3.dxf

The reported luminous flux is the flux emitted by the light source with a tolerance of  $\pm 10\%$  compared to the indicated value. The W tot column indicates the total wattage absorbed by the system without exceeding 10% of the indicated