

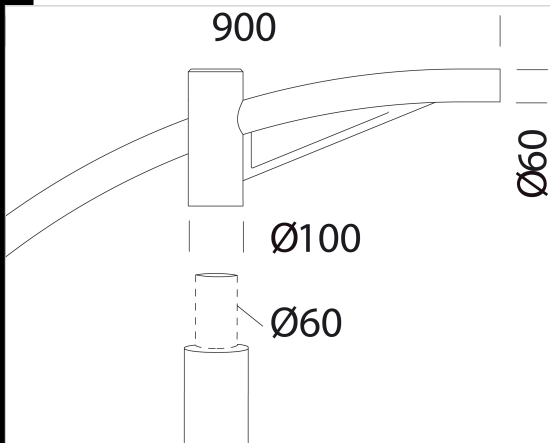

504 - Single arm

En acero, ideal para la instalación sobre columnas de Ø60.



































Código	Kg	WTot	Color
991262-00	8.50	0 W	GREY9007
991263-00	9.10	0 W	GRAFITO
991264-00	8.50	0 W	ANTRACITA

Productos



El flujo luminoso mostrado indica el flujo de salida de la luminaria con una tolerancia de \pm el 10% respecto al valor indicado. Los W tot son la potencia total absorbida por el sistema y no superan el 10% del valor indicado.

Productos

	- 3375 Mini Stelvio - high performance - tipo vial		- 3376 Mini Stelvio - high performance - grandes áreas		- 3370 Stelvio - high performance - tipo vial		- 3374 Stelvio - high performance - grandes áreas
	- 3296 Sella 1 - HP		- 3396 Sella 2 - HP		- 3393 Sella 2 - asimétrico 60°		- 3480 Mini Giovi - high performance - grandes áreas
	- 3481 Mini Giovi - high performance - alumbrado vial ME		- 3482 Mini Giovi - high performance - carril bici		- 3475 Mini Giovi W1 - alumbrado vial		- 3476 Mini Giovi W2 - alumbrado vial
	- 3477 Mini Giovi N1 - carril bici		- 3478 Mini Giovi M1 - alumbrado vial		- 3479 Mini Giovi T4 - grandes áreas		- 3486 Mini Giovi izquierdo (IZO) - pasos peatonales
	- 3487 Mini Giovi derecho (DER) - pasos peatonales		- 3483 Mini Giovi ÁMBAR - grandes áreas		- 3484 Mini Giovi ÁMBAR - alumbrado vial ME		- 3485 Mini Giovi ÁMBAR - carril bici
	- 3490 Giovi - high performance - grandes áreas		- 3491 Giovi - high performance - alumbrado vial ME		- 3473 Giovi W1 - alumbrado vial		- 3495 Giovi W2 - alumbrado vial
	- 3472 Giovi M1 - alumbrado vial		- 3474 Giovi M2 - alumbrado vial		- 3496 Giovi - izquierdo (IZO) -		- 3497 Giovi - derecho (DER) -
	- 3494 Giovi T4 - asimétrico -		- 3492 Giovi ámbar T4 - grandes		- 3493 Giovi ámbar - alumbrado		- 3297 Sella 1 - izquierdo (IZO) -
	- 3298 Sella 1 - derecho (DER) -						

El flujo luminoso mostrado indica el flujo de salida de la luminaria con una tolerancia de \pm el 10% respecto al valor indicado. Los W tot son la potencia total absorbida por el sistema y no superan el 10% del valor indicado.