

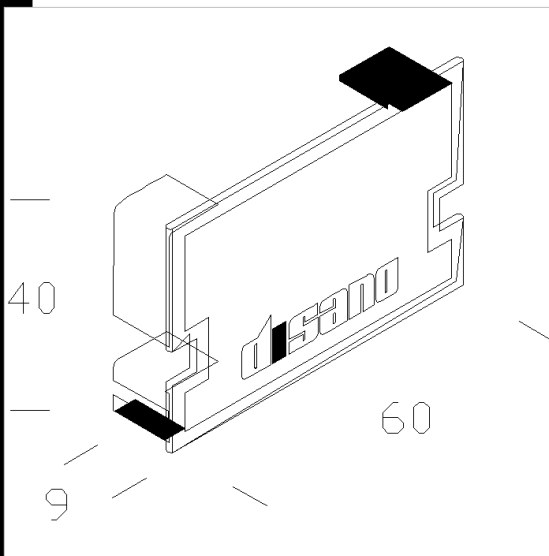





















6045 Tapa final

De material termoplástico blanco. Permite el cierre de la parte final del carril.



Código	Kg	WTot	Color
132909-00	0.01	0 W	BLANCO

Productos

 - 6000 Rapid System - carril	 - 6502 Rapid system -	 - 6402 Rapid system -	 - 6600 Techno System -
 - 6601 Techno System - asimétrico 25° - CRI 90	 - 6602 Techno System - bi-asimétrico 25° - CRI 90	 - 6603 Techno System - elíptico 30°x80° - CRI 90	 - 6604 Techno System - extensivo 60° - CRI 90
 - 6605 Techno System - extensivo difusor semiesférico - CRI 90	 - 6600 Techno System - simétrico 90° - CRI 80	 - 6601 Techno System - asimétrico 25° - CRI 80	 - 6602 Techno System - bi-asimétrico 25° - CRI 80
 - 6603 Techno System - elíptico 30°x80° - CRI 80	 - 6606 Techno System HE - UGR - CRI 80	 - 6605 Techno System - extensivo - con difusor semiesférico - de techo	 - 6611 Techno System HE - simétrico 90° - CRI 80
 - 6615 Techno System HE -	 - 6614 Techno System HE -	 - 6612 Techno System HE -	 - 6613 Techno System HE - bi
 - 6616 Techno System HE - extensivo difusor semiesférico - CRI 80	 - 6617 Techno System HE - 90° Opal symmetric - CRI 80		

El flujo luminoso mostrado indica el flujo de salida de la luminaria con una tolerancia de \pm el 10% respecto al valor indicado. Los W tot son la potencia total absorbida por el sistema y no superan el 10% del valor indicado.