

235 60mm pole mounting

Made of aluminium. To be used to apply the fixture on a $\varnothing 60$ pole.

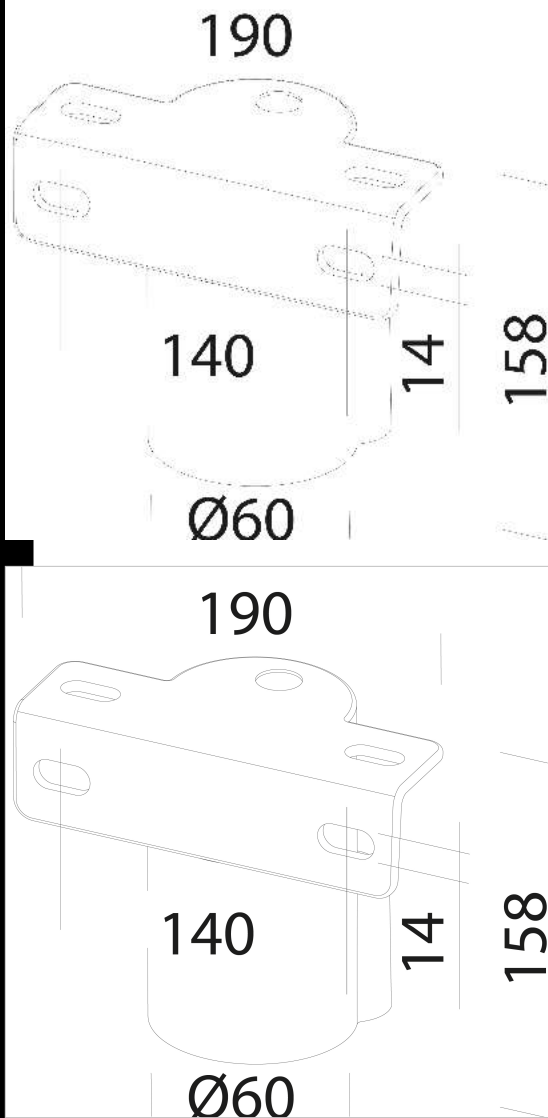

Download

DXF 2D
- 235.dxf

Code	Kg	WTot	Colour
997927-00	1,20	0 W	GRAPHITE

Prodotti



- 2886 Saturno - asymmetric 45°



- 2887 Saturno - asymmetric 60°



- 2890 Saturno $\varnothing 320$ - wide



- 2889 Saturno $\varnothing 320$ - narrow



- 2890 Saturno $\varnothing 370$ - wide beam



- 2889 Saturno $\varnothing 370$ - narrow beam

The reported luminous flux is the flux emitted by the light source with a tolerance of $\pm 10\%$ compared to the indicated value. The W tot column indicates the total wattage absorbed by the system without exceeding 10% of the indicated