

1525 Elfo 35/70W narrow beam

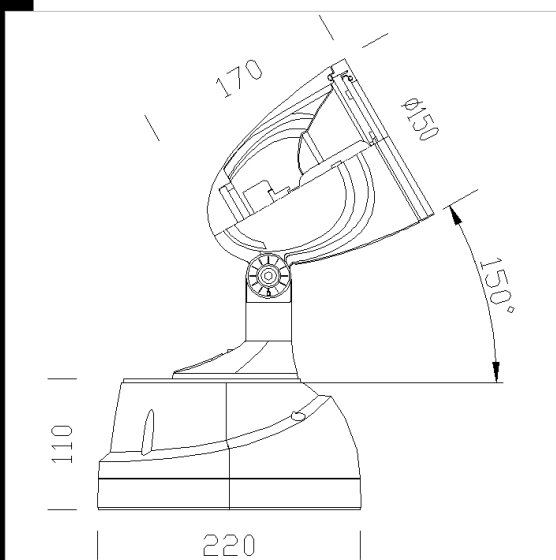





Housing: Die-cast aluminium with cooling fins
 Reflector: Anodised and polished turned aluminium
 Diffuser: Tempered glass 4 mm thermal shock and impact resistant
 Coating: the standard liquid immersion coating consists of a first metal surface pre-treatment stage, a successive epoxy cataphoresis corrosion and salt resistant coating, and a final layer of bi-component acrylic liquid UV-stabilised coating.
 Lampholder: Ceramic with silver-plated contacts
 Electric gear: 230V power supply with heat protection. Wire terminated with admiralty brass clamps, silicone insulation cross section: 1 sqmm. 2P terminal block (maximum allowed lead cross section 2.5 sqmm.)
 Equipment: Silicone rubber gasket. Fibreglass nylon cable gland, Ø ½ " gas.
 Regulations: Manufactured in compliance with EN60598 - CEI 34 - 21 standards. The level of protection complies with the EN60529 standard.



- Download**
 DXF 2D
 - 1525_elfo.dxf
 3DS
 - disano_1525_elfo.3ds
 3DM
 - disano_1525_elfo.3dm
 Montaggi
 - elfo.pdf

Code	Gear	Kg	Lumen-K-CRI	WTot	Base	Colour
432022-00	CNR-L	2,65	CDM-T 35-3500lm-3000K-Ra 1b	42 W	G12	GRAPHITE
432021-00	CNR-L	2,65	CDM-T 70-6600lm-4200k-Ra 1b	83 W	G12	GREY9006
432020-00	CNR-L	2,65	CDM-T 35-3500lm-3000K-Ra 1b	42 W	G12	GREY9006
432023-00	CNR-L	2,65	CDM-T 70-6600lm-4200k-Ra 1b	83 W	G12	GRAPHITE

Accessori

 - 119 peg	 - 120 pole mount	 - 186 conveyor	 - 187 four-sided shutter
 - 189 coloured filter	 - 190 baffle louvre	 - 188 plate	

The reported luminous flux is the flux emitted by the light source with a tolerance of ± 10% compared to the indicated value. The W tot column indicates the total wattage absorbed by the system without exceeding 10% of the indicated