

Vision 2.0 small - Tiges - Universal adapter

Housing: Die-cast aluminium with cooling holes.
 Reflector: in die-cast aluminium, high efficiency and anti-glare.
 Coating: Power-coated with a UV-resistant polyester paint.
 Regulations: Manufactured in accordance with EN 60598-1-CEI 34.21 standards. Degree of protection in accordance with EN60529 standards.
 Luminous flux maintenance 80%: 50.000h (L80B20).
 Power factor >0.95
 Photobiological safety class: exempt group EN62471.
 design: A.Pedretti (Studio Rota & partner)
 DALI dimmable version -1241 -6841 to be used with OMNITRACK PLUS track-mounted system.

Download

DXF 2D
 - 703610.dxf

Montaggi
 - VISION2.0 rev7.pdf

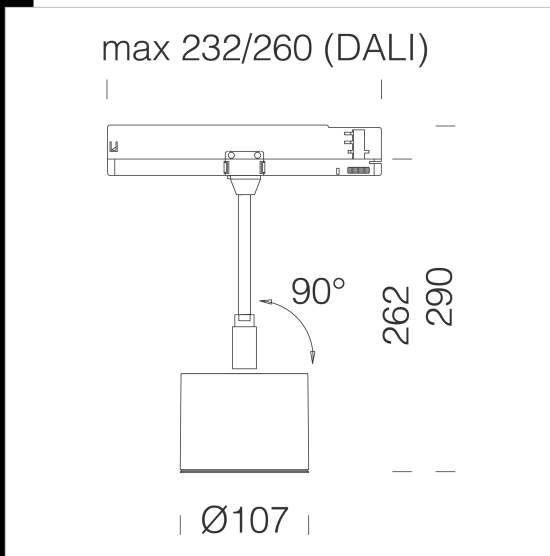

Code	Gear	Kg	Lumen Output-K-CRI	WTot	Colour
22703610-00	CLD CELL	1,00	LED COB-3631lm-3000K-44°-CRI 92	34 W	WHITE
22703630-00	CLD CELL	0,69	LED COB-3631lm-3000K-44°-CRI 92	34 W	BLACK
22703670-00	CLD CELL	0,69	LED COB-3631lm-3000K-44°-CRI 92	34 W	SILVER
22703610-68	CLD CELL	0,69	LED COB-3885lm-4000K-44°-CRI 92	34 W	WHITE
22703630-68	CLD CELL	0,69	LED COB-3885lm-4000K-44°-CRI 92	34 W	BLACK
22703670-68	CLD CELL	0,69	LED COB-3885lm-4000K-44°-CRI 92	34 W	SILVER

The reported luminous flux is the flux emitted by the light source with a tolerance of ± 10% compared to the indicated value. The W tot column indicates the total wattage absorbed by the system without exceeding 10% of the indicated