

Eco Lex 3

Eco Lex LED is a new series of recessed spotlights that combines advanced technology and energy savings with an easy-to-install, low cost, robust and durable fixture. Available in three sizes with a diam. of 100, 164, 192, 220 mm, they cover a wide range of cutout holes.

Housing: in die cast aluminium

Diffuser: The shield consists of a laser-cut slab that serves as a lens for its effect of concentric circles. These decorations create a pattern, with variable distances; the closer they get to the centre, the closer they come together achieving excellent visual comfort without glare

Painting: dust painted, using polyester epoxy paint to withstand UV rays.

Standard supply: Includes adjustable steel bracket.

Regulations: Manufactured in accordance with standards EN60598 – CEI 34 –21. Degree of protection in accordance with standards EN60529.

Power factor: 0.9

Photobiological safety class: Exempt group.

Luminous flux maintenance 80%: 50.000h (L80B20).

recessed Ø 198/216mm

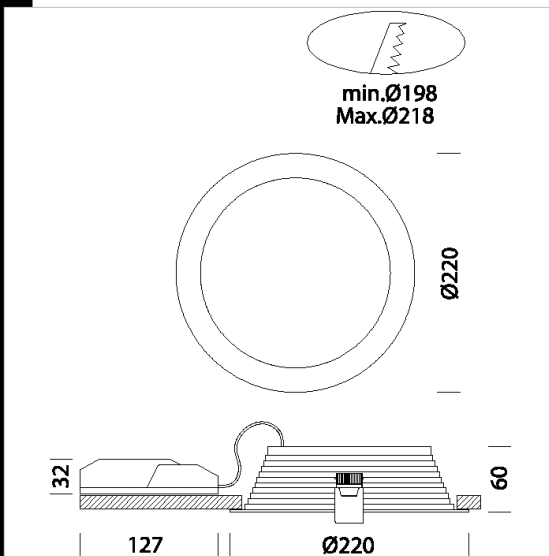

Code	Gear	Kg	Lumen Output-K-CRI	WTot	Colour
22172916-00	CLD	0,80	LED-2190lm-4000K-CRI>90	21 W	WHITE
22172906-00	CLD	0,80	LED-2070lm-3000K-CRI>90	21 W	WHITE

Accessori



- EM Kit Q



- Protective grig - Eco Lex



Download

DXF 2D
- ecolex3.dxf

Montaggi
- ECO_LEX_LED rev12.pdf

The reported luminous flux is the flux emitted by the light source with a tolerance of $\pm 10\%$ compared to the indicated value. The W tot column indicates the total wattage absorbed by the system without exceeding 10% of the indicated