

Trimless 50 - A2

Housing: in die-cast aluminium with adjustable and tilting spotlights.
 Equipment: equipped with galvanised steel support brackets which guarantee perfect attachment to suspended ceiling from 12 mm to 25 mm thick.
 Reflector: high-efficiency metallised polycarbonate. Regulations: Manufactured in accordance with standards EN60598 – CEI 34 –21. Degree of protection in accordance with standards EN60529.
 LED: High-efficiency light sources (CRI 90).
 Power factor: >= 0.95
 Photobiological safety class: Exempt group.
 Luminous flux maintenance 80%: 50.000h (L80B20).
 recessed Ø 184x94mm

Download

DXF 2D
 - trim50a2.dxf

Montaggi
 - TRIMLESS A 50-70-111 rev5.pdf

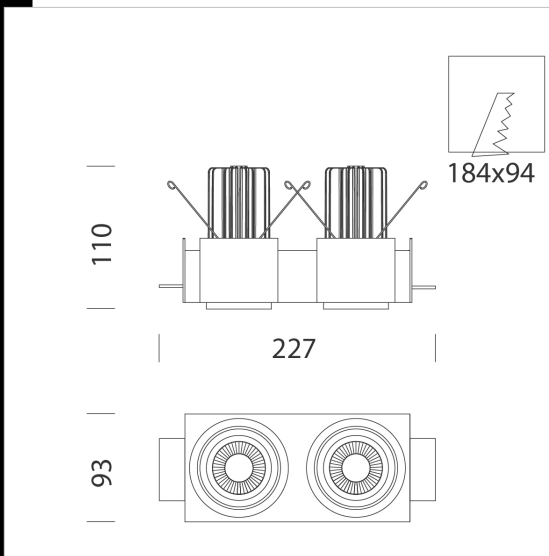

Code	Gear	Kg	Lumen Output-K-CRI	WTot	Colour
22105230-00	CLD	1,30	LED COB2x-505lm-3000K-15°-CRI 90	20 W	BLACK
22105230-1241	CLD-D-D	1,70	LED COB2x-505lm-3000K-15°-CRI 90	20 W	BLACK
22105231-00	CLD	1,70	LED COB2x-543lm-4000K-15°-CRI 90	20 W	BLACK
22105231-1241	CLD-D-D	1,70	LED COB2x-543lm-4000K-15°-CRI 90	20 W	BLACK
22105232-00	CLD	1,30	LED COB2x-479lm-3000K-25°-CRI 90	20 W	BLACK
22105232-1241	CLD-D-D	1,70	LED COB2x-479lm-3000K-25°-CRI 90	20 W	BLACK
22105233-00	CLD	1,30	LED COB2x-515lm-4000K-25°-CRI 90	20 W	BLACK
22105233-1241	CLD-D-D	1,70	LED COB2x-515lm-4000K-25°-CRI 90	20 W	BLACK
22105234-00	CLD	1,30	LED COB2x-425lm-3000K-40°-CRI 90	20 W	BLACK
22105234-1241	CLD-D-D	1,70	LED COB2x-425lm-3000K-40°-CRI 90	20 W	BLACK
22105235-00	CLD	1,30	LED COB2x-457lm-4000K-40°-CRI 90	20 W	BLACK
22105235-1241	CLD-D-D	1,30	LED COB2x-457lm-4000K-40°-CRI 90	20 W	BLACK

The reported luminous flux is the flux emitted by the light source with a tolerance of ± 10% compared to the indicated value. The W tot column indicates the total wattage absorbed by the system without exceeding 10% of the indicated