

Download

DXF 2D  
- 27075.dxf

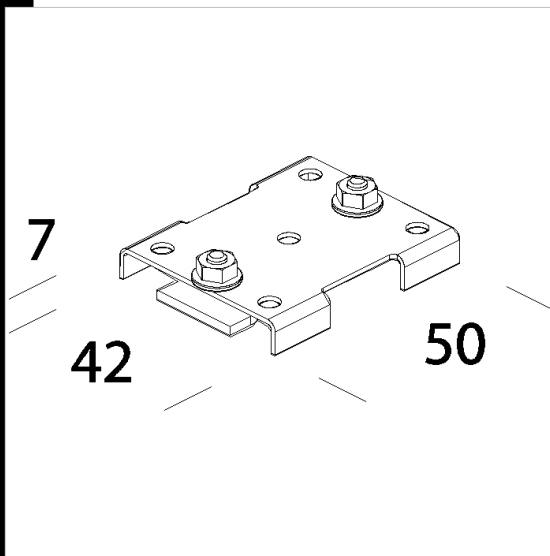

Code	Kg	WTot	Colour
22027075-00	0.06	0 W	OXIDIZED

Products



- Maxi Liset IP54 LED



- Maxi Liset IP40 LED



- Maxi Liset IP54



- Maxi Liset IP40 - Full light

The reported luminous flux is the flux emitted by the light source with a tolerance of  $\pm 10\%$  compared to the indicated value. The W tot column indicates the total wattage absorbed by the system without exceeding 10% of the indicated