

6045 end cap

Made of white thermoplastic material. Used to close the end section of track.

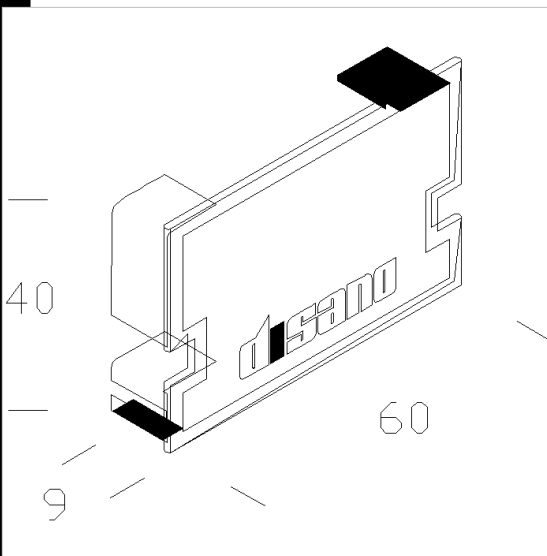

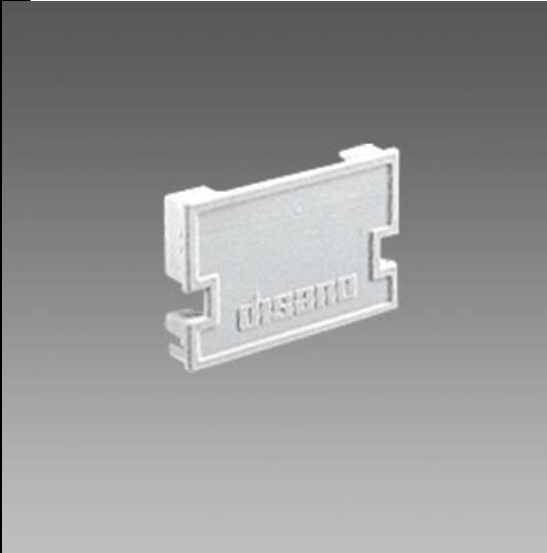



















Download

DXF 2D  
- d6045.dxf



| Code      | Kg   | WTot | Colour |
|-----------|------|------|--------|
| 132909-00 | 0,01 | 0 W  | WHITE  |

Prodotti

|  |   |  |   |
|--|---|--|---|
|  - 6000 Rapid System - power  |  - 6502 Rapid system - 2-lamps                         |  - 6402 Rapid system - 1-lamp  |  - 6600 Techno System - 90°                        |
|  - 6601 Techno System - 25° asymmetric - CRI 90                       |  - 6602 Techno System - 25° bi-asymmetric - CRI 90     |  - 6603 Techno System - 30°x80° elliptical - CRI 90                        |  - 6604 Techno System - 60° wide-beam - CRI 90     |
|  - 6605 Techno System - wide-beam semi-spherical diffuser - CRI 90    |  - 6600 Techno System - 90° symmetric - CRI 80         |  - 6601 Techno System - 25° asymmetric - CRI 80                            |  - 6602 Techno System - 25° bi-asymmetric - CRI 80 |
|  - 6603 Techno System - 30°x80° elliptical - CRI 80                   |  - 6606 Techno System HE - UGR - CRI 80                |  - 6605 Techno System - wide-beam - with semi-spherical diffuser - Ceiling |  - 6611 Techno System HE - 90° symmetric - CRI 80  |
|  - 6615 Techno System HE - 60°  |  - 6614 Techno System HE -                             |  - 6612 Techno System HE - 25°   |  - 6613 Techno System HE - 25°                     |
|  - 6616 Techno System HE - wide-beam semi-spherical diffuser - CRI 80 |  - 6617 Techno System HE - 90° Opal symmetric - CRI 80 |  |   |

The reported luminous flux is the flux emitted by the light source with a tolerance of ± 10% compared to the indicated value. The W tot column indicates the total wattage absorbed by the system without exceeding 10% of the indicated