

6020 T joint

Made of galvanized steel with a white thermoplastic material cover. For jointing of 3 tracks. To be used in combination with acc. 6622.

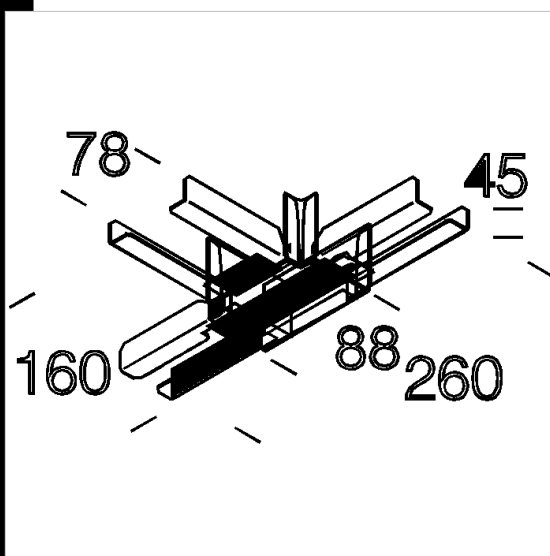

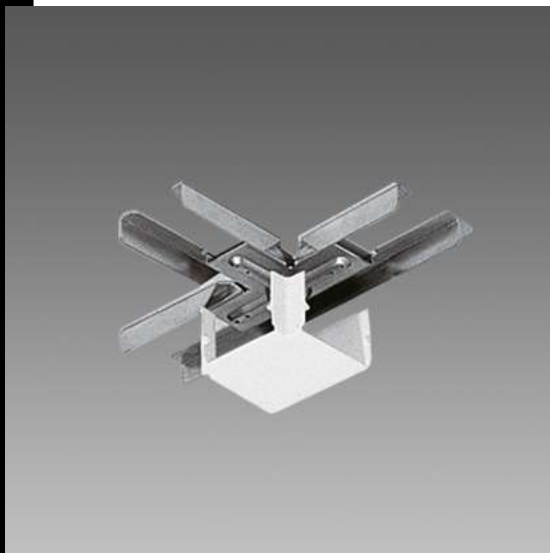

















Download

DXF 2D
- d6020.dxf



Code	Kg	WTot	Colour
132904-00	0,32	0 W	WHITE

Prodotti

 - 6000 Rapid System - power	 - 6502 Rapid system - 2-lamps	 - 6402 Rapid system - 1-lamp	 - 6600 Techno System - 90°
 - 6601 Techno System - 25° asymmetric - CRI 90	 - 6602 Techno System - 25° bi-asymmetric - CRI 90	 - 6603 Techno System - 30°x80° elliptical - CRI 90	 - 6604 Techno System - 60° wide-beam - CRI 90
 - 6605 Techno System - wide-beam semi-spherical diffuser - CRI 90	 - 6600 Techno System - 90° symmetric - CRI 80	 - 6601 Techno System - 25° asymmetric - CRI 80	 - 6602 Techno System - 25° bi-asymmetric - CRI 80
 - 6603 Techno System - 30°x80° elliptical - CRI 80	 - 6606 Techno System HE - UGR - CRI 80	 - 6611 Techno System HE - 90° symmetric - CRI 80	 - 6615 Techno System HE - 60° wide-beam - CRI 80
 - 6614 Techno System HE -	 - 6612 Techno System HE - 25°	 - 6613 Techno System HE - 25°	 - 6616 Techno System HE - wide-beam semi-spherical
 - 6617 Techno System HE - 90° Opal symmetric - CRI 80			

The reported luminous flux is the flux emitted by the light source with a tolerance of ± 10% compared to the indicated value. The W tot column indicates the total wattage absorbed by the system without exceeding 10% of the indicated