

203 Fusibile

Fusibile da 3.15A. Con portafusibile da installare internamente alla plafoniera







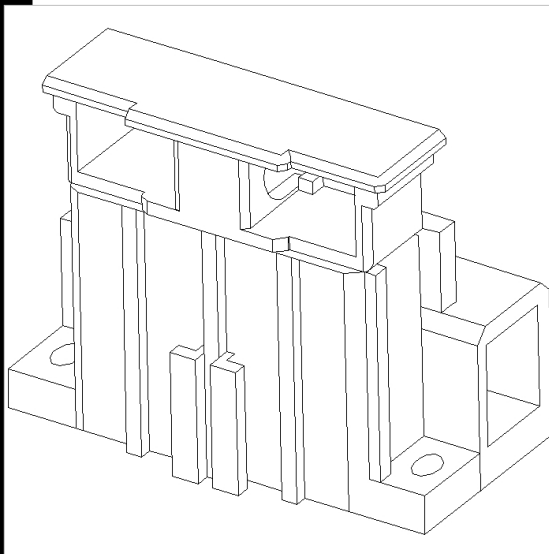
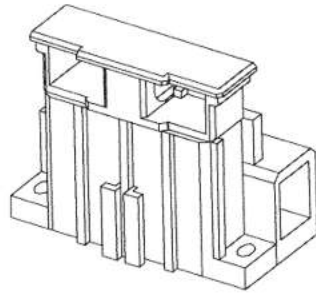





Download

DXF 2D
- acc_203_portafusibile.dxf



Code	Kg	WTot
984814-00	0,01	0 W

Prodotti

 - 863 Comfort 65° T5 - ottica	 - 877 Comfort T8 - ottica satinata	 - 865 Comfort 65° T5 - ottica	 - 865 Comfort 65° T8 - ottica
 - 874 Comfort T8 - ottica speculare 99.99 bordo largo	 - 864 Comfortlight T8 - ottica speculare 99.85	 - 864 Comfortlight T5 - ottica speculare 99.85	 - 875 Comfort T8 - ottica satinata 99.99
 - 873 Comfort T8 - ottica speculare 99.99	 - 850 Minicomfort T5 ottica speculare 99.99	 - 853 Minicomfort T5 ottica speculare 99.85	 - 873 Comfort T5 - ottica speculare 99.99
 - 875 Comfort T5 - ottica satinata 99.99	 - 860 Comfortlight T8 - ottica satinata 99.85	 - 860 Comfortlight T5 - ottica satinata 99.85	 - 863 Comfort 65° T8 - ottica speculare 99.85

The reported luminous flux is the flux emitted by the light source with a tolerance of $\pm 10\%$ compared to the indicated value. The W tot column indicates the total wattage absorbed by the system without exceeding 10% of the indicated